

LG CordZero™

USER'S MANUAL

A9

Make sure to read the "Safety Cautions" carefully before starting to use this product.

Please keep this User's Manual within easy reach of the user.

As the product is only intended for domestic use such as household cleaning, it must not be used for commercial, experimental or industrial purposes.

Make sure to fully charge the product's battery before first use of the product after purchasing it.



MFL69883606

www.lg.com

Copyright © 2018 LG Electronics Inc. All Rights Reserved.

TABLE OF CONTENTS

This User's Manual may contain images or contents that differ slightly to the purchased product.

SAFETY CAUTIONS	04
PACKAGE INFORMATION	10
INSTALLATION	11
Installing the standing charging station	11
Installing the wall-mount station	12
Uninstalling the station.....	12
Storage of the combination tool and crevice tool.....	12
HOW TO USE	13
Note about using the product.....	13
Using the Product.....	13
Charging the Product.....	14
Power / Suction Strength button.....	14
Using the nozzles	15
MAINTENANCE	16
Cleaning the Dustbin.....	16
Cleaning the Filters	16
Cleaning the Power Drive Floor/Carpet Nozzle	18
Cleaning the Bedding Power Punch	18
POINTS TO CHECK BEFORE CONTACTING CUSTOMER SERVICE.	19
DISPOSAL INFORMATION	20
Disposal of old products not related with the purchase of a new product.....	20
PRODUCT SPECIFICATIONS	20

SAFETY PRECAUTIONS

The following cautions are intended to protect you from unexpected risk or property loss by ensuring safe and correct usage of the product.

Cautions are categorized into 'Warning' and 'Caution', which mean:



Pictograms are designed to draw attention to matters and uses that may pose a risk to the user. Make sure to carefully read any item marked with this symbol and comply with it to prevent any risk.



WARNING

Failure to comply with this warning may result in serious damage, injury or even death to the user.



CAUTION

Failure to comply with this warning may result in damage to the product or moderate injury to the user.

WARNING

1. This appliance is not intended for use by persons (including children) with reduced physical, sensory or mental capabilities, or lack of experience and knowledge, unless they have been given supervision or instruction concerning use of the appliance by a person responsible for their safety.
2. Children should be supervised to ensure that they do not play with the appliance.
3. If the supply cord is damaged, it must be replaced by an LG Electronics Service Agent in order to avoid a potential hazard.
4. This appliance can be used by children aged 8 years and above and persons with reduced physical, sensory or mental capabilities or lack of experience and knowledge if they have been given supervision or instruction concerning use of the appliance in a safe way and understand the hazards involved. Children shall not play with the appliance.
Cleaning and user maintenance must not be performed by children without supervision.

Installation and Usage

Do not install, charge or store the product where it may be exposed to water, rainfall or severe moisture. Do not use the product in any outdoor location, workshop or garage environment.

- Such conditions will leave the product vulnerable to fire when charging the battery.
- Please install, charge or store the product in a well-ventilated place.

Make sure to avoid places where there is a risk of leakage of flammable gas, industrial oil or metallic dust.

- It may cause product malfunction or damage.

If you intend to use the charging station by "standing" it vertically (standing type), make sure to secure it to the wall with the appropriate type of screws .

- Otherwise, the charging station or product may slant and become damaged or cause property damage or injury.

Please place the charging station on an even surface.

- Otherwise, the product may fall and sustain damage or cause an injury.

If you intend to mount the charging station on a wall (wall-mounted type), make sure to secure it tightly to the wall using the appropriate type of screws.

- Failure to do so may damage the product and/or cause an injury.

Please use the anchoring screws only when the wall is made of concrete or is solid enough.

- If the Station mounting is performed on an unsuitable wall it may cause injury and damage the property or product.

Never install the charging station on a wall with any piping (gas, water, air) or power cables or wires behind it.

- There is a risk of injury from electric shock, fire or flooding.

Do not use or store the product at temperatures below 5 ° C or above 38 ° C.

- Failure to do so may damage the product.

Power requirements

This product should only be used with AC 230-240V. Make sure to check the power specifications of the place where you intend to use the product.

- The wrong specifications will result in electric shock or damage the product in the event of a short-circuit.

Do not apply excessive force to the power cord to bend it, or place it under a heavy object as this will damage it.

- The power cord may get damaged and cause electric shock or injury.

Please refrain from using multiple power appliances in one power board or power socket and make sure to use a power socket with a capacity of 10A.

- Failure to do so may result in fire due to abnormal overheating of the socket.
- Or it may activate the circuit breaker leading to a loss of power.

Never touch the power cord and plug with a wet hand.

- This may result in injury or electric shock.

Please clear any dust or water from the power cord and plug with a dry cloth.

- Failure to do so may result in electric shock, short circuit or fire.

When unplugging the power cord, never pull the cord itself and always hold the power plug.

- Failure to do so will damage the cord it and may result in electric shock or fire.

Stop using the product and contact the customer service department of LG Electronics if the power cord or power plug is damaged or the holes of the power outlet socket are loose.

- Failure to do so may result in electric shock or fire.

Make sure to unplug the power cord when cleaning or maintaining the charging station.

- Failure to do so may result in injury or electric shock.

Make sure to unplug the power cord when the product is not to be used for an extended period of time.

- Failure to do so may result in electric shock, short circuit or fire.

Make sure to organize the power cord of the Adaptor while using or cleaning the product.

- Otherwise, the cord may get tangled with the product and result in malfunction, electric shock or injury if its disconnected or broken.

Avoid touching the pins of the power plug with your finger(s) when unplugging the power cord.

- Failure to do so may result in electric shock or fire.

Do not to let children or pets get close to the product when using, charging or storing.

- It may damage the product and/or result in injury.

Do not hold the charging station upside down with the battery in the charging station.

- Otherwise, it may damage the product and/or result in injury.

Proper usage

Make sure that no child is allowed to use the product.

- The product is too heavy for a child to handle properly.

Make sure that no hand, foot, hair or clothes gets stuck in the rotating brush or wheel while using or cleaning the product.

- Failure to do so may damage the product or result in injury.

No one other than a qualified technician/service engineer from LG Electronics may disassemble, repair or modify the product.

- Do not attempt to disassemble or repair the product yourself as it may result in electric shock, injury or fire.

Never use the battery, the charging station and the adaptor with other appliances other than this product.

- It may cause a product malfunction or fire.

Do not use the battery of another appliance in the product.

- It may cause malfunctioning or fire.

Do not arbitrarily disassemble, remove or short-circuit the battery.

- It may result in electric shock, injury or fire.

Do not apply heat or shock to the battery.

- It may cause electric shock, injury or fire.

Never insert a sharp metallic object such as a pin, nail or knife in a hole or gap in the product or the charging station.

- Otherwise, you may get injured or suffer electric shock.

Do not vacuum liquids with this product. Make sure that no water, beverage or detergent gets inside the product or the charging station.

- Failure to do so may result in injury or electric shock.

Do not apply or spray a flammable substance (gasoline or thinner) or surface active agent (detergent or bath soap) on the product.

- It may result in malfunction or fire.

In the event of a gas leakage (propane or urban gas), make sure to ventilate the area first without coming into contact with the product or its power plug.

- Otherwise, there may be sparks which may result in an explosion, fire or injury.

Do not use or store a heating device or flammable substance(ether, benzene, alcohol, chemicals, combustible spray, insecticide, air freshener or cosmetics) in close proximity to the product.

- It may result in product malfunction or fire.

Do not attempt to clean up a liquid substance (water, beverage), odorous substances (candy, chocolate, pet excrement, etc.), metallic objects (such as blade, pins), flammable substances, surface active agents, or glass shards with this product.

- It may result in product malfunction or fire.

- In the event that any liquid, metallic object, glass shard or spark gets inside the product, immediately turn off the product and contact the customer service department of LG Electronics.

Do not use the product with the exhaust or inlet port blocked.

- It will cause the product to overheat and result in malfunction or fire.

In the event that smoke is emitted by the product while it is charging, immediately unplug the power cord and contact the customer service department of LG Electronics.

- Failure to do so may cause electric shock or fire.

Do not expose the product, and the battery in particular, to heat, a heating device or direct sunlight.

- It may result in electric shock, explosion or fire.

Do not keep the product or its battery inside a vehicle which is exposed to direct sunlight.

- It may cause fire or explosion.

In the event that some kind of liquid leaks from the battery, make sure that it does not contact the skin or eyes.

- It may burn the skin or severely damage the eyes.
- If liquid from the battery comes into contact with part of the skin, immediately wash it off with plenty of water and seek medical advice.

Do not wash the inlet port with water or detergent.

- As the inlet port contains a motor, it may result in electric shock or fire.

Always use the charging station and adaptor provided with the product to charge the product and its battery.

- Using any charging device other than the provided station and adaptor will damage the battery and result in electric shock, explosion or fire.

Never allow any water, beverage or detergent to get inside the battery.

- It may cause electric shock, explosion or fire.

Do not touch the charging terminals on the product or the charging station, or insert an electrified object inside the product or the station.

- Otherwise, you may get injured or suffer electric shock.

Always leave the product on the floor standing or wall-mount charging station when it is not in use. Do not leave the product on the charging station not fixed to the wall or charging station support.

- Otherwise, the product may fall and get damaged or cause injury.

In the event that the earth leakage breaker gets activated while the product is placed on the charging station, immediately remove the product from the station and contact the customer service department of LG Electronics.

- Failure to do so may cause electric shock or fire.

Do not wash the dust bin with water.

- The water will get into the motor and cause electric shock or fire.

Do not attempt to vacuum fine dust such as cement with the product.

- It may cause product malfunction or fire.

Make sure that no child can play with the product, charging station or battery.

- It may damage the product and cause an injury.
- If a child places the product or battery into its mouth, it will cause electric shock or injury, or damage the product or battery.

When using the product, remove any wire or string from the bottom of the Charging Station.

- Straps or wires may wrap around the product and cause a product malfunction or a broken cord.

Disposal

Discard the packing materials (plastic vinyl, styrofoam) properly so that no child comes into contact with them.

- Such materials may cause a child to suffocate.

When disposing of the product, make sure to remove the battery from the product's body.

- Failure to do so may result in fire or explosion.

CAUTION

Proper usage

Do not apply impact to the product or drop it from a height.

- It may damage the product and/or result in injury.

Make sure that the product does not fall.

- It may cause injury or damage the product.

Make sure that the filter is installed in the product prior to each use.

- Failure to install a filter may result in product malfunction.

Make sure to wipe up any liquid such as water or oil or pet excrement from the floor before using the product.

- Such substances will cause the unit to malfunction or cause irreparable damage

Do not clean the product with a volatile or organic solvent (thinner or acetone).

- It may damage the product.
- Always use a soft cloth to clean the product.

Make sure to avoid running into a person or a pet while using the product.

- It may cause injury.

Do not kick or apply impact to the product.

- It may cause the product to malfunction.

Do not put any object other than the product, especially a metallic or magnetic object, on the charging station.

- It may damage the product or cause electric shock.

Do not clean the same spot repeatedly for an extended period of time.

- Vibration from the inlet port or rotating brush may damage the floor or the carpet.

Make sure that your finger does not get stuck when assembling the product or the charging station.

- It may injure your finger.

Do not let a child or a pet hang onto the charging station.

- It may cause injury or damage the product.

Do not put double-sided tape directly onto the wallpaper as it may be torn by external force.

- Anchor the charging station with the wall anchoring screw(s) to prevent tearing of the wallpaper.

Do not apply force or impact to the filter parts or dust bin parts.

- The parts may become deformed, compromise the performance or cause the unit to malfunction.

PACKAGE INFORMATION

Standing type

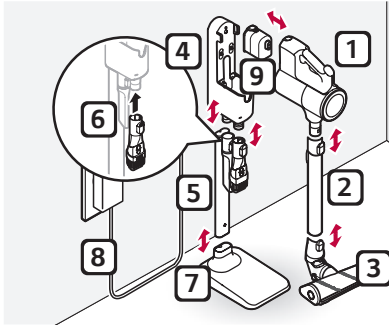

Wall-mount type

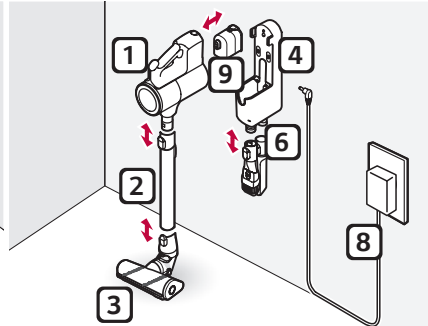

- 1 Product body
- 2 Extension pipe
- 3 Power Drive Carpet Nozzle

- 4 Charging station
- 5 Charging station pipe
- 6 Combination tool and crevice tool

- 7 Charging station support
- 8 Adaptor
- 9 Battery holder

Accessories

- Parts and accessories may vary depending on the model that you have purchased.



Product body

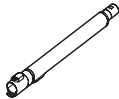

Extension pipe

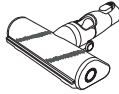

Power Drive Carpet Nozzle

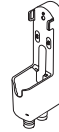

Charging station



Adaptor



Battery



Crevice Tool



Combination Tool



Wall Anchoring Block



Double-sided tape (2)



Screw Anchor (2)



Anchoring screw for wall-mount type (Φ 3.5 mm, length 50 mm)(2)



Anchoring screw for standing type (Φ 3.5 mm, length 90 mm)



Pre-filter

- Please note that these parts come with their corresponding models only.



Battery



Power Drive Floor Nozzle



Bedding Power Punch

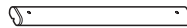

Charging station pipe

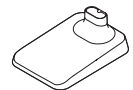

Charging station support

INSTALLATION

Installing the floor standing charging station

- 1 Put the bottom of the charging station onto the floor and assemble the pipe first, followed by the upper body mount.

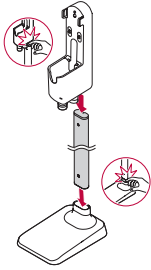

⚠ CAUTION

- Avoid getting your fingers stuck in any gap.
- 2 Connect the power adapter to the port on the back of the charging station and plug the power cord into the power outlet.
 - The cord can be secured tidily by putting it through the power cord anchoring ring located on the back of the charging station pipe.

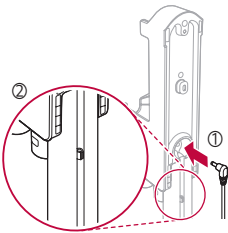

- 3 After ensuring there are no pipes or wires inside behind the wall, make a hole at the appropriate height to anchor the charging station and insert the screw anchor.

- Recommended diameter of hole: $\Phi 6.5$;
Recommended depth: 50~100 mm.

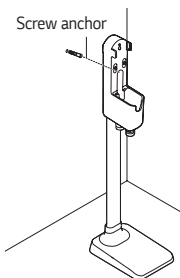

- 4 Put the anchoring block on the back of the charging station and anchor the charging station with the screw.
 - Make sure to fully tighten the screw.

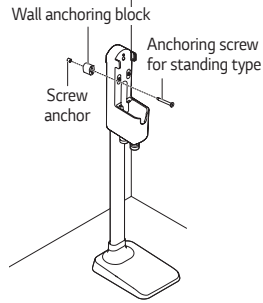

When using double-sided tape (do not use if the wall is wallpapered)

- 1 Use double-sided tape to attach the wall anchoring block to the charging station in step 4.
 - Be sure to remove the center part of the double-sided tape before mounting it.

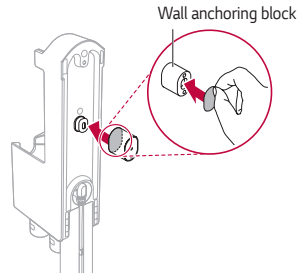

- 2 Use the remaining part of the tape to anchor the station to the wall before inserting the screw.

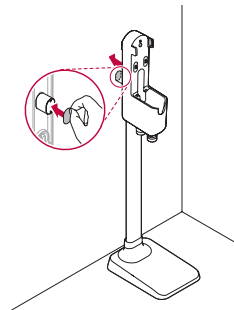

CAUTION

- Avoid dropping the product and parts when taking them out of the package. It may damage the product and/or cause personal injury.
- Do not use double-sided tape to anchor the charging station on papered walls. Please use the provided screws as otherwise the wall paper will get torn by movement of the charging station during the docking of the unit.
- We recommend anchoring the station with the anchoring screw.
- Use the anchoring screws only when the wall is made of concrete or is solid enough. An unsuitable wall can cause the mountings to weaken and cause the Charging station to fall causing injury and damage the property or product.

Please note

- The charging station, its pipe and support cannot be disassembled separately once they have been assembled, and the charging station has been attached to the wall.
- The charging station can be removed as needed. After unscrewing it from the wall, pull the station upward whilst the bottom of the station remains upright on the floor.

Installing the wall-mount station

- 1 Connect the power adapter to the port on the back of the charging station and plug the power cord into the power outlet.
- 2 Make a hole 1 meter from the floor to insert the wall plug or screw anchor.
 - Recommended diameter of hole: $\Phi 6.5$;
 - Recommended depth: 60 mm.
- 3 Anchor the station to the wall with the provided anchoring screws.

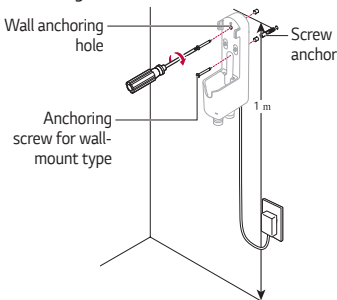

Please note

- A service request to change the installation location of the charging station will incur additional costs if required to do so by a qualified installer.

Uninstalling the station

Keep and charge the product on the charging station after separating extension pipe and nozzle from the product body.

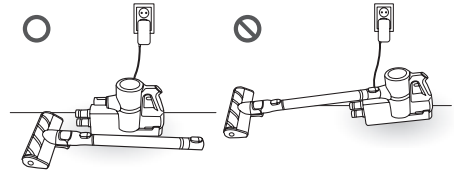

CAUTION

- Leaving the extension pipe and nozzle assembled for a long time may cause damage to the product.

Storage of the combination tool and crevice tool

Keep the combination tool and crevice tool on the charging station for easy access.

- 1 Attach the combination tool and crevice tool to the dedicated holders.

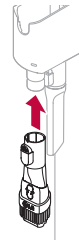

- 2 Press and hold the inlet removal button and pull downward to remove the combination tool or crevice tool.



HOW TO USE

Note about using the product

Points to be aware of when using the product

- Make sure that the dustbin lid is on prior to using the product. Otherwise, the suction strength will deteriorate and cleaning will not be satisfactory.
- Support the bottom of the product when cleaning an elevated surface.
- When leaving the product unattended or unused for an extended period, make sure to place it properly on the charging station or lie it on the floor. Otherwise, the product may fall and get damaged or cause an injury.
- Make sure that the exhaust filter is properly assembled before using the product.
- Environmental conditions such as temperature and humidity may cause static to accumulate on the product. Please contact the customer service department of LG Electronics if the problem persists.
- Any foreign object on the inlet port or extension pipe will prevent the product from functioning properly. Make sure to remove any foreign object such as a sock or stocking before using the product.
- The battery runtime will be shortened after using the product repeatedly for an extended period due to its characteristics.
- When the battery is about to become fully run down during use, the last block on the battery indicator will start to flash and the product will power off after a while. Fully charge the battery in this case.
- Please use the product at normal room temperatures as the battery runtime will deteriorate severely if used at temperatures lower than 5°C or higher than 38°C for an extended period of time.
- Refer to Product specifications for battery run time details.
- These times are a guide only and may be less depending on the surface type.

Using the Product

- 1 Assemble the body, extension pipe, inlet port, and battery in that order.

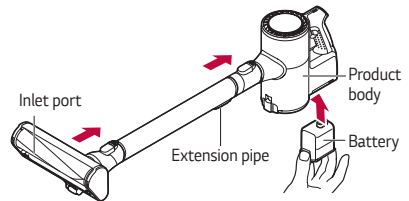

- 2 Press the button on the extension pipe to adjust its length.

- The pipe has 4 extendable length positions

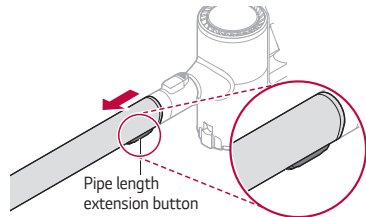

- 3 Attach the accessory tool to the body or the extension pipe.

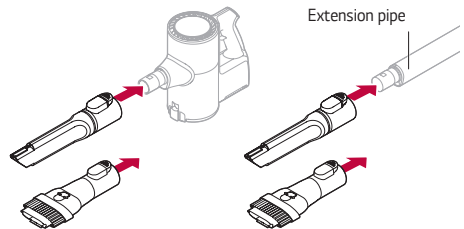

⚠ CAUTION

- Prolonged use of the product with the accessory tool attached may overburden the motor.
- Using the inlet port to clean a TV, monitor or LCD display may scratch the screen.
- Exercise caution to avoid getting your finger stuck in any gap when assembling the attachments.
- If any foreign object is sucked into the inlet during cleaning, operation of the vacuum cleaner might stop in order to prevent damage to the body or motor. Immediately stop using the vacuum cleaner and remove the object before resuming cleaning.

Charging the Product

- 1 Put the product on the charging station.
 - The battery indicator will start to flash and charging will proceed in 3 steps.

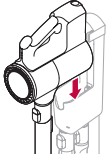

- 2 The battery indicator starts to flash and charging will start.
 - All of the indicators will stay on when the battery is fully charged.

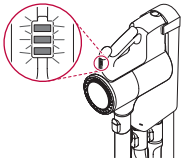

CAUTION

- Make sure to securely fit the unit on to the charging station. Otherwise, the product may fall and get damaged.

Please note

- The battery will not be charged if the ambient temperature is below 5°C. Only charge the battery when ambient temperatures are between 5° and 38° C.
- The battery indicator will flash if the product is fully charged, removed from the station, and charged again soon. The flashing stops soon, and the indicator stays on.

Charging the auxiliary battery

- 1 Hold the product and pull the battery by pressing both ends of the battery.

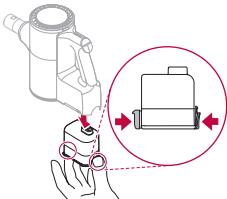

- 2 Insert the battery into the auxiliary charging station.

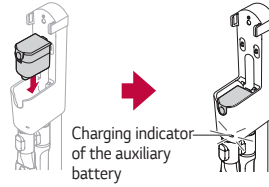

Please note

- Make sure that the power adapter is connected to both the charging station and the power outlet
- If the main battery is charging on the charging station, the auxiliary battery will only start charging once the main battery is fully charged.
- The auxiliary battery indicator flashes when charging starts.
- The indicator will stay on when the auxiliary battery is fully charged.
- Fully charging a single battery usually takes 4 hours, but it will take twice as long if you charge it along with a discharged auxiliary battery.

Power / Suction Strength button

You can adjust the suction strength with the suction strength button located on the handle.

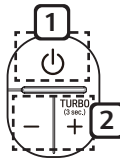

- 1 Power On/Off button

- Press the power On/Off button to activate the Normal mode.

- 2 Mode button

- Press "+" once to activate the Power mode.
- Press and hold "+" for more than 3 seconds to activate the Turbo mode.
- The unit will take a moment to switch to the Turbo mode from the Normal mode when the "+" button is held down.
- Press "-" to switch from Turbo to Power, or from Power to Normal.

Using the nozzles

- Please note that the following applies to the corresponding models:
- The nozzle can be attached to the product body or extension pipe.
- Use a different mode if the inlet gets stuck on the floor, carpet or bed sheets or if you need a more powerful mode.

CAUTION

- Do not use the product for any purpose other than domestic household.

Power Drive Carpet Nozzle

- It is suitable for cleaning carpets or rugs.
- It can be used to clean hard floors but will generate some noise.

CAUTION

- Do not use this nozzle on a play mat (PVC) for children.

Power Drive Floor Nozzle (some models only)

- It is suitable for cleaning hard floor surfaces.

Bedding Power Punch (some models only)

- Bedding Power Punch lets you clean bed sheets and covers more effectively. This attachment can be used to remove Pet Hair from various surfaces without hair tangling.
- Make sure to adjust the suction level to an appropriate setting when you vacuum-clean a blanket with a thin outer fabric as the cleaner may attempt to suck the outer fabric.

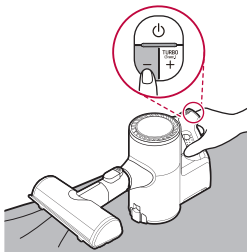

Crevice Tool

It is suitable for cleaning dust in a corner or a narrow space.

Combination Tool

This accessory is helpful for cleaning corners or small gaps.

Basic

For cleaning flat surfaces such as a sofa or mattress.

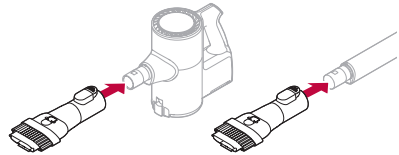

Brush type

For cleaning delicate surfaces such as a frame or furniture.

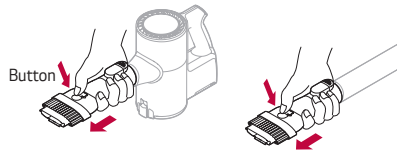

CAUTION

- Prolonged use of the product with an accessory tool attached may over heat the motor.
- Using this accessory tool on a TV, monitor or LCD display may scratch the screen.
- Avoid getting your finger stuck in any gaps when fitting the accessory tools.
- If any foreign object is sucked into the inlet during cleaning, operation of the unit might stop in order to prevent damage to the body, motor or inlet. Immediately stop using the vacuum cleaner and remove the object before resuming cleaning.

Cleaning the the Dustbin

- 1 Remove the battery from the unit before cleaning the dustbin.
- 2 Please empty the dustbin next to a wastebasket or where dust and foreign objects can be emptied easily.
- 3 Press the dustbin button downward to open it.
 - Empty the bin.
 - Be careful as dust/foreign matter may spill out when you open the dustbin.

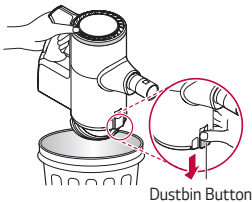

- 4 Insert the crevice tool into the large dust separation device (Cyclonic Mesh Filter) and turn it counterclockwise to remove it. Use the suction end of the crevice tool to do this with ease.

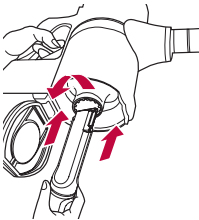

- 5 Wash the large dust separation device (Cyclonic Mesh Filter) with running water.
 - Be sure to dry the device completely before reinserting it.

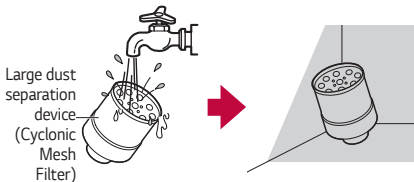

- 6 Remove the Cyclone and use the combination tool to clean out the dust inside the dustbin.

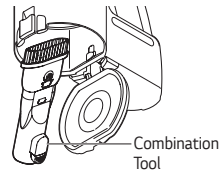

⚠ WARNING

- Never wash the product's body with water. Water may reach the motor and cause electric shock or fire.
- Do not apply force or any impact to the dust bin parts or the Cyclone as it may damage them.
- Use the product only after cleaning the Cyclone and reassembling it on the product. Failure to do so will damage the product.

Cleaning the Filters

The Pre-filter and exhaust filter need to be cleaned at least once a month to maintain the cleaning performance of the product.

- 1 Turn the exhaust filter counterclockwise to remove it and take out the pre-filter.

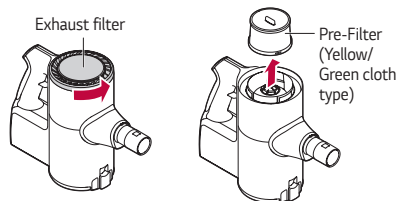

- 2 With the unit upside down, use the combination tool to clear dust from the motor part once the Dust separator filter has been removed.

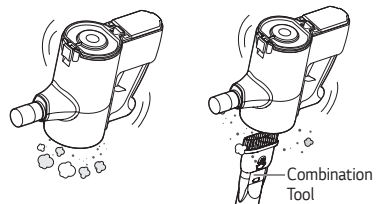

3 Clean the exhaust filter by brushing the dust off or by washing it in running water.

- To maintain cleaning performance, remove the dust from the exhaust filter at least once a month.



- Wash the exhaust filter in running water if it emits an odor.
- The exhaust filter may emit an odor if it is not dried completely after it has been cleaned in water. Make sure to dry it completely for 24Hrs before refitting it.

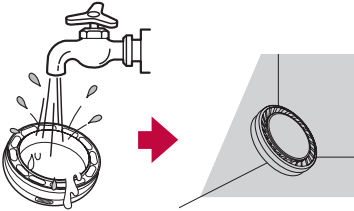

4 Clean the pre-filter by brushing the dust off or by washing it in running water.

- When washing the cloth type Pre-filter with water, it must be completely dry before reinserting. Failing to do so will cause it to emit odours.
- The more often the filters are cleaned, the more optimal the suction power will be.
- Filters are consumables and will wear with time and use. Please purchase more filters from an authorized service center.

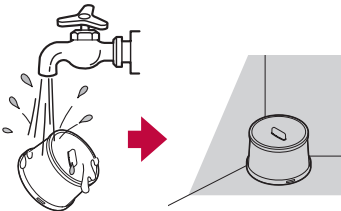

5 To refit the filters, attach the Pre-filter first, followed by the exhaust filter, so as to align the white circle near the battery level indicator and then turn it clockwise so that the white circles align with each other.



⚠ WARNING

- Never wash the product's body with water as it may reach the motor and result in electric shock or fire.
- Make sure that no foreign object reaches the motor as it will damage the product and may result in explosion or fire.
- Do not insert a finger or a sharp object near the motor as it will damage the product and may result in injury or electric shock.

⚠ CAUTION

- Make sure to reattach the exhaust filter and Pre-filter to the product after washing them. Using the product without these filters will allow dust to reach the motor inside the product and cause malfunction.

Please note

- As too much dust will reduce the suction power, we recommend cleaning the filters before and after using the product.

✘ Removing foreign objects from inside the product

In order to maintain product performance, be sure to remove any foreign objects and dust from inside the product (body, extension pipe, inlets). The foreign materials inside the product can cause the product to shutdown during operation, generate noise, or cause poor suction.

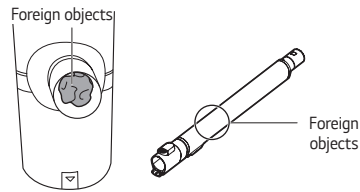

Product body

Extension pipe

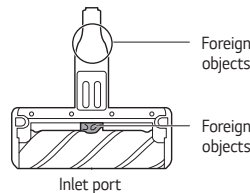

Foreign objects

Foreign objects

Inlet port

- ✘ If the inside of the product body, Extension pipe, or Inlet port is clogged with foreign objects, the power automatically turns off to protect the product. Separate the battery from the product and remove the foreign objects.

Cleaning the Power Drive Floor/ Carpet Nozzle

Please clean the floor and carpet nozzles as follows:

- 1 Remove the nozzle from the product.
- 2 Turn the nozzle upside down and turn the rotating brush removal screw counterclockwise.
 - Use a coin or a flat head screwdriver to turn the screw.

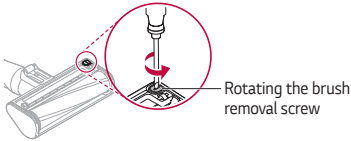

- 3 Pull the brush in the direction of the arrow to remove it.

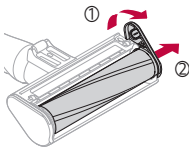

- 4 Attach the crevice tool to the unit and use the vacuum to remove dust/foreign objects from the brush and the bottom of the nozzle.

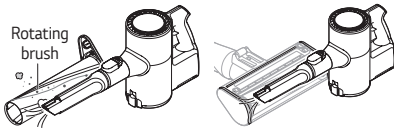

- 5 Use a wet towel or tissue to remove any remaining foreign matter and dust from the brush and the bottom of the nozzle.

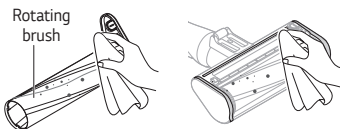

- 6 Assemble the brush in reverse order after cleaning.

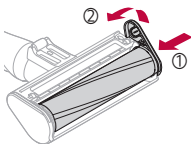

⚠ CAUTION

- Avoid getting your finger stuck in any gaps when reassembling.
- Do not wash the rotating brush and the nozzle with water.
- Do not use the rotating brush as a mop.
- Do not use the nozzle to absorb any liquid.

Cleaning the Bedding Power Punch

- 1 Remove the Bedding Power Punch and turn it upside down.
- 2 Attach the crevice tool to the unit and use the vacuum to remove dust/foreign objects from the bottom of the Bedding Power Punch.

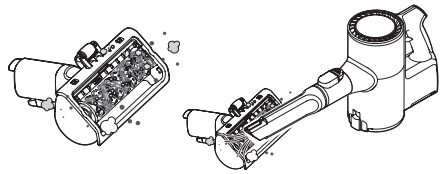

- 3 Use a wet towel or tissue to move any remaining foreign matter and dust.

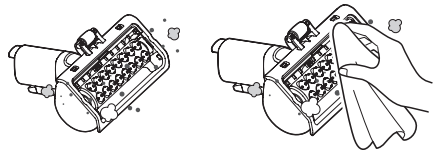

⚠ WARNING

- Do not wash the Bedding Power Punch with water.
- Do not suck any liquids including water into the Bedding Power Punch.

POINTS TO CHECK BEFORE CONTACTING CUSTOMER SERVICE.

Please check once again if one of the following symptoms is present while using the product. The product may not be malfunctioning.

Symptom	Cause	Solution
The product does not operate.	<ul style="list-style-type: none"> Is the battery fully discharged? Is the product powered off? 	<ul style="list-style-type: none"> Charge the battery. Press the power button to power on the product.
Suction is too weak.	Is the dustbin full of dust?	<ul style="list-style-type: none"> Empty the dustbin.
	Is the filter clogged?	<ul style="list-style-type: none"> Clean the pre-filter. If suction is still weak after cleaning the pre-filter, please contact the customer service department for advise
	Is the inlet clogged?	
The unit does not appear to be charging.	Is there a foreign object on the rotating brush of the inlet port?	<ul style="list-style-type: none"> Make sure to remove any foreign objects (thread, hair) from the rotating brush.
	Is the power adapter connected to the charging station?	<ul style="list-style-type: none"> Make sure that the adapter is properly plugged into the charging station.
	Is the power cord plugged into the outlet?	<ul style="list-style-type: none"> Make sure that the power cord is properly plugged into the power outlet.
Hot air is expelled from the unit.	Is there any foreign object on the charging terminals?	<ul style="list-style-type: none"> Remove any foreign objects from the charging terminals with a dry cloth.
	Is it operating properly?	<ul style="list-style-type: none"> The hot air originates from cooling of the motor and is not a sign of malfunction.
A strange odor is coming from the product.	Did you purchase the cleaner within the last 3 months?	<ul style="list-style-type: none"> The cleaner may emit a smell of rubber for about 3 months after purchase.
	Is it operating properly?	<ul style="list-style-type: none"> If the cleaner is working fine, it is not malfunctioning.
	Is the dustbin full of dust?	<ul style="list-style-type: none"> Also, dust in the bin may cause some odor. Empty the bin and clean it.
	Are there any foreign objects in the filter?	<ul style="list-style-type: none"> The filter may emit an odor if it has not been cleaned for some time. Clean both the pre-filter and the exhaust filter.
	Is the Pre-filter wet?	<ul style="list-style-type: none"> Washing the pre-filter with water and not leaving it long enough to dry completely may cause it to smell. Make sure to dry it completely before reassembling it on the cleaner.
The cleaner makes too much noise.	Is the exhaust filter wet?	<ul style="list-style-type: none"> Washing the exhaust filter with water and not leaving it long enough to dry completely may cause it to smell. Make sure to dry it completely before reassembling it on the cleaner.
	Is it operating properly?	<ul style="list-style-type: none"> Different levels of noise is normal during operation due to three power settings. It is not a sign of malfunction.
The unit powers off too soon.	Is the battery fully charged?	<ul style="list-style-type: none"> The battery must be fully charged before cleaning. If the problem persists even though the battery is fully charged, and the pipes and attachments are clear from obstructions, then please contact LG customer service
	Is there any foreign substance in the body of the product, Extension pipe, or Inlet port?	<ul style="list-style-type: none"> Remove the foreign objects from the body of the product, Extension pipe, or Inlet port.
The rotating brush does not rotate.	Is the brush properly attached?	<ul style="list-style-type: none"> Remove the brush, clean it if necessary and attach it again.
	Are there any foreign objects on the rotating brush?	<ul style="list-style-type: none"> Remove any foreign objects from the rotating brush.

DISPOSAL INFORMATION

Disposal of old products not related with the purchase of a new product

You must contact your local city council or the related government authority before disposing of large appliances.

PRODUCT SPECIFICATIONS

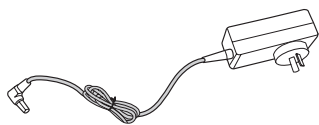
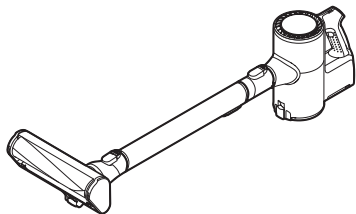

Item/Model	A9*****
Dimensions	260 mm(W) X 270 mm(L) X 1120 mm(H)
Weight	2.7 kg
Power consumption:	400 W (Maximum power: 450 W)/ 250 W/ 80 W (Turbo/Power/ Normal)
Suction power	140 W (In Turbo mode) 1)
Battery	DC 25.55 V
Battery runtime (When fully charged, and without using the Power Drive nozzles)	Approx. 6 minutes in Turbo
	Approx. 9 minutes in Power
	Approx. 40 minutes in Normal
Battery runtime (When fully charged, and using the Power Drive nozzles)	Approx. 6 minutes in Turbo
	Approx. 9 minutes in Power
	Approx. 30 minutes in Normal

Item	Charger (Adaptor)
Input	100 V - 240 V~ 50/60 Hz, 0.8 A
Output	DC 29.4 V 1.0 A

Item/Model	Battery
Type	Rechargeable Li-ion Battery
Rated	DC 25.55 V , 2000 mAh, 7 cells

1) Suction Power test based on IEC 62885-2, 5.8.

Note

Note

Note

LG CordZero™